

ALA-1 SERIES

COMPACT LINE ARRAY LOUDSPEAKER SYSTEM

DESCRIPTION

The **ALA-1 SERIES** is designed to provide extremely high fidelity, controlled pattern, and uniform coverage in small- and medium-sized venues such as houses of worship, auditoriums, and screening rooms. This easy to use system takes the difficulty out of designing and installing with line arrays.

The main array (ALA-1) incorporates four metal-alloy woofer cone drivers featuring the pioneering voice-coil guidance system by NEAR, utilizing a unique Ferrofluid in the magnet gap. Nearly 20 years of proven performance in the field makes this woofer design the highest definition and most reliable driver on the market. Listeners will experience realism and musical detail unlike any other compact line-array loudspeaker they have ever heard.

The Long-Throw module (ALA-1LT) increases the array length by 50%, focusing this extra energy to augment and extend the performance of the ALA-1 for longer distances. Both models (ALA-1 & ALA-1LT) also use horn-loaded high frequency metal dome drivers for added clarity and detail in the upper ranges, without the harshness of traditional high-frequency units. Like the woofers, each high frequency unit incorporates Ferrofluid for increased thermal capacity, better damping, and longer life in harsh environments.

The Down-Fill module (ALA-1DF) increases vertical coverage below the main array greatly improving articulation in front row nearfield listening areas often eliminating the need for stage-based front fill speakers.

When the application requires high-output low-frequency energy, the ALA-1S is a perfect partner to the rest of the ALA system. Its unique mounting bracket allows the full ALA-1 Line Array to be suspended and tilted. A neodymium driven 12-inch woofer provides high output and extended bass for music and video productions. Combined with the other ALA modules, the full system represents the most cost-effective way to achieve a true professional-quality system with unmatched realism.



ALA-1 LOUDSPEAKER

ENGINEERING DATA *Performance Specifications (in blue)*

FORMAT:
Passive/Two-way Line Array

COVERAGE ANGLES:
HORIZONTAL: 130°
VERTICAL: Graduated 10° up,
35° down

FREQ. RESPONSE (1M ON AXIS):
64 Hz to 18 kHz (+/- 3 dB)

SENSITIVITY (1W @ 1M): 94 dB

MAX. SPL (@1M):
121 dB cont./127 dB peak

NOMINAL IMPEDANCE: 8-ohms

MAX. POWER HANDLING:
500W cont./2000W peak

DIMENSIONS:
height: 27-5/8" (702mm) H
width: 14-1/8" (359mm) W
depth: Top- 9-7/8" (251mm) D
Bottom- 6-1/4" (155mm) D
weight: 39 lb. (17.7 kg)

DRIVER COMPLEMENT:
(4) 6-1/2" metal-alloy
cone drivers;
(12) 1" horn-loaded metal
diaphragm drivers

INPUT CONNECTORS:
Barrier Strip, #8 Screw Type

RIGGING HARDWARE:
101-2000 Yoke (sold
separately),
Allen Products MM-120

OPTIONS/ACCESSORIES:
DLC24 Digital Controller,
Stand Fitting for Yoke
(140-05)



ALA-1LT LONG-THROW LOUDSPEAKER

ENGINEERING DATA *Performance Specifications when added to the ALA-1 (in blue)*

FORMAT:
Passive/Two-way Line Array

COVERAGE ANGLES:
HORIZONTAL: 130°
VERTICAL: Graduated 15° up,
35° down

FREQ. RESPONSE (1M ON AXIS):
64 Hz to 18 kHz (+/- 3 dB)

SENSITIVITY (1W @ 1M): 95 dB

MAX. SPL (@1M):
123 dB cont./129 dB peak

NOMINAL IMPEDANCE: 4-ohms
(Wired in parallel w/ALA-1)

MAX. POWER HANDLING:
750W cont./3000W peak

DIMENSIONS:
height: 14-1/8" (359mm) H
width: 14-1/8" (359mm) W
depth: 9-7/8" (251mm) D
weight: 24 lb. (10.9 kg)

DRIVER COMPLEMENT:
(2) 6-1/2" metal-alloy
cone drivers

DRIVER COMPLEMENT (CONT'D):
(6) 1" horn-loaded metal
diaphragm drivers

INPUT CONNECTORS:
Barrier Strip, #8 Screw Type

RIGGING HARDWARE:
101-2001 Coupling Plates
(two units included w/ALA-1LT)

OPTIONS/ACCESSORIES:
DLC24 Digital Controller



ALA-1S SUBWOOFER

ENGINEERING DATA *Performance Specifications (in blue)*

FORMAT: Dual-Vented, Single
Amp, Electronically Coupled

FREQ. RESPONSE (1M ON AXIS):
40 Hz to 140 Hz (+/- 3 dB)

SENSITIVITY (1W @ 1M): 96 dB

MAX. SPL (@1M):
122 dB cont./128 dB peak

NOMINAL IMPEDANCE: 8-ohms

MAX. POWER HANDLING:
300W cont./1200W peak

DIMENSIONS:
height: 17-7/8" (454mm) H
width: 14-1/8" (359mm) W
depth: 16-5/8" (422mm) D
weight: 35 lb. (15.8 kg)

DRIVER COMPLEMENT:
(1) 12" Weatherproof Cone
Woofers w/Neodymium Magnet
Structure

INPUT CONNECTORS:
Barrier Strip, #8 Screw Type

RIGGING HARDWARE:
101-2000 Yoke (sold
separately),
101-2001 Coupling Plates
(two units included w/ALA-1S)

OPTIONS/ACCESSORIES:
DLC24 Digital Controller



ALA-1DF DOWN-FILL LOUDSPEAKER

ENGINEERING DATA *Performance Specifications when added to the ALA-1 (in blue)*

FORMAT: Passive/Line Array

COVERAGE ANGLES:
HORIZONTAL: 130°
VERTICAL: Graduated 10° up,
50° down

MAX. SPL (@1M):
119 dB cont./125 dB peak*

*When used with ALA-1

INPUT CONNECTORS:
Barrier Strip, #8 Screw Type

DIMENSIONS:
height: 13-1/2" (343mm) H
width: 14-1/8" (359mm) W
depth: Top- 11" (279mm) D;
Bottom- 2-3/4" (70mm) D

weight: 14 lb. (6.4 kg)

DRIVER COMPLEMENT:
(6) 1" horn-loaded metal
diaphragm drivers

RIGGING HARDWARE:
101-2001 Coupling Plates
(two units included w/ALA-1DF)

POLAR MEASUREMENTS ALA-1 (6 dB/division, normalized)

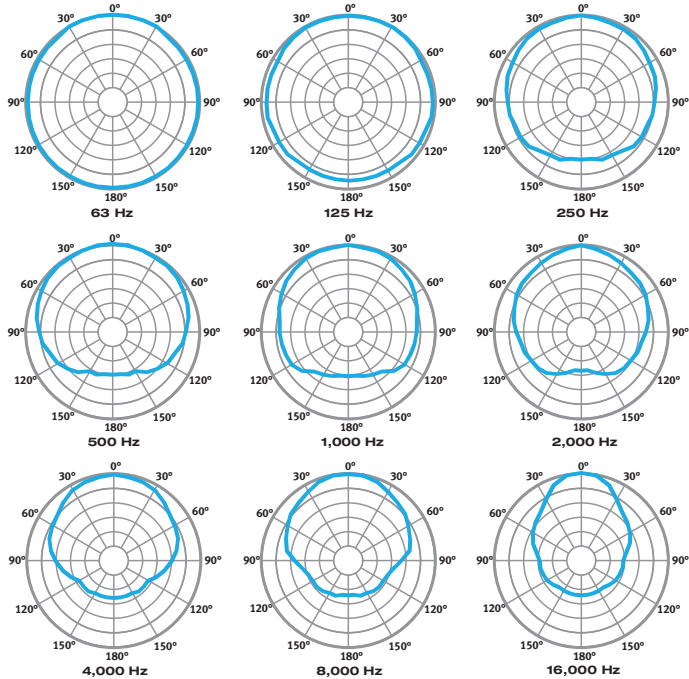

HORIZONTAL 
All polar measurements obtained in a free-field environment at 10° increments.

FREQUENCY RESPONSE ALA-1 & ALA-1LT

Measured in a free-field anechoic environment using a swept one-third octave input.

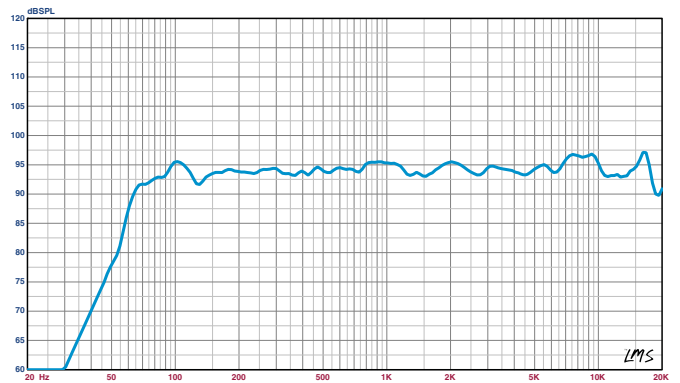

PROCESSOR NOTES:

The DLC24 Digital Loudspeaker Controller is a digital engine with an analog surface. It combines the most advanced technology available with intuitive interfaces to provide the key elements that ensure optimal loudspeaker system performance and management in a variety of live sound and fixed installation applications.

The controller provides factory-set equalization curves to smooth the response, protect limiting, and active crossovers (for bi-amplified models and subwoofers). XLR Connector inputs and outputs are standard on the DLC24 Digital Loudspeaker Controller.

ALA-1 VERTICAL COVERAGE

The ALA-1 is a 4 element line array, pre-articulated and fixed in a single enclosure. The preset vertical coverage creates a 10 degree high output zone at the top of the array to better reach the back of the average venue. Sound Pressure Level below this high output on axis zone gradually decreases towards the bottom of the array. Because the listening area covered by the bottom of the array is generally closer to the speaker and the Sound Pressure Level from the speaker is reduced in this area, Sound Pressure levels will remain very consistent from the back of a venue to the front.

When a greater vertical coverage angle is required to cover audience areas at the front of the venue, the ALA-1DF (Down-Fill) module may be added, increasing vertical coverage by 15 degrees. If higher Sound Pressure Levels are desired, because of the use of the venue or because of its depth, the ALA-1LT (Long Throw) module may be added. This module increases the on axis level by 3 dB and the vertical coverage by 5 degrees. The relative level of each module has been preset so a complete array including the LT and DF can be connected to a single amplifier channel.

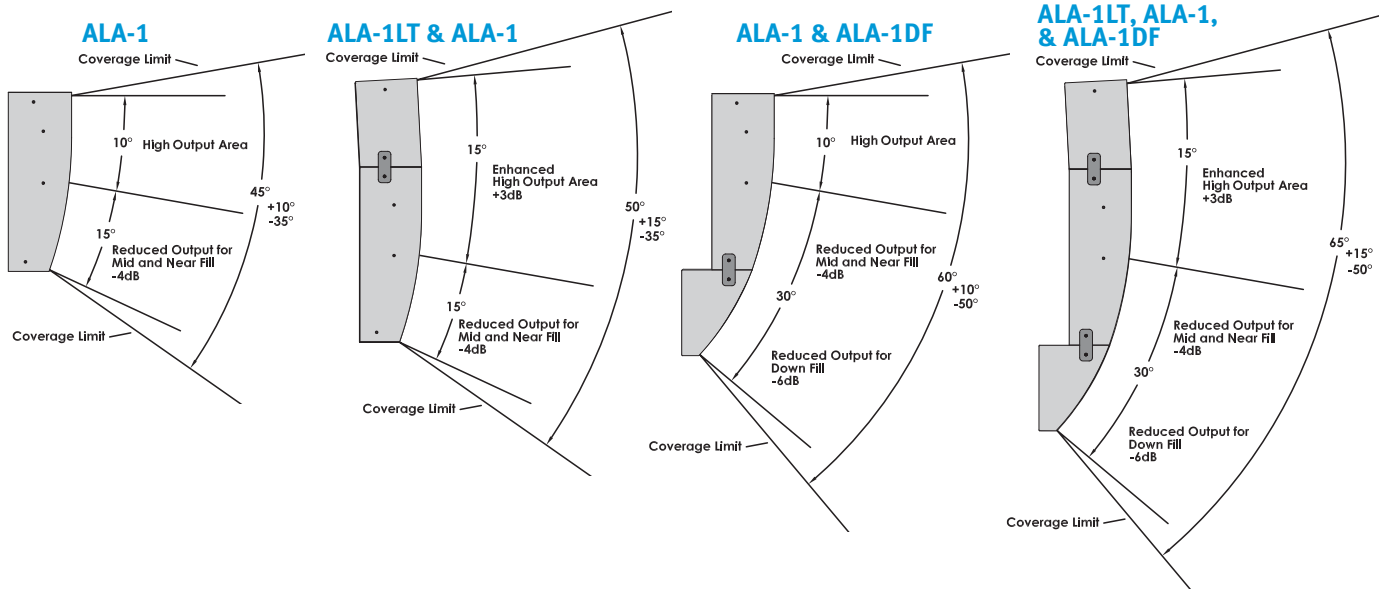

RIGGING OPTIONS

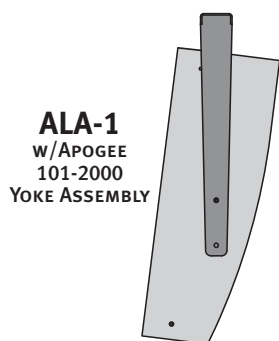

ALA-1
w/APOGEE
101-2000
YOKE ASSEMBLY

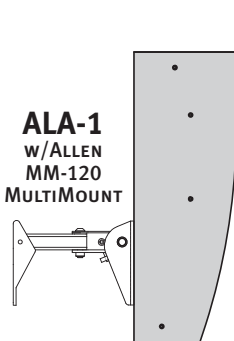

ALA-1
w/ALLEN
MM-120
MULTIMOUNT

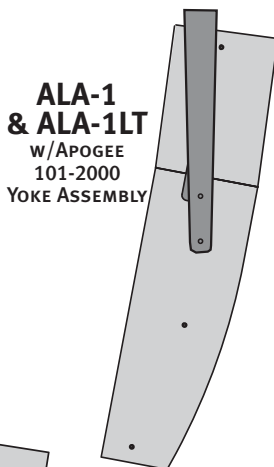

**ALA-1
& ALA-1LT**
w/APOGEE
101-2000
YOKE ASSEMBLY

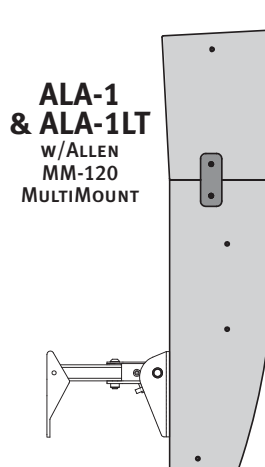

**ALA-1
& ALA-1LT**
w/ALLEN
MM-120
MULTIMOUNT

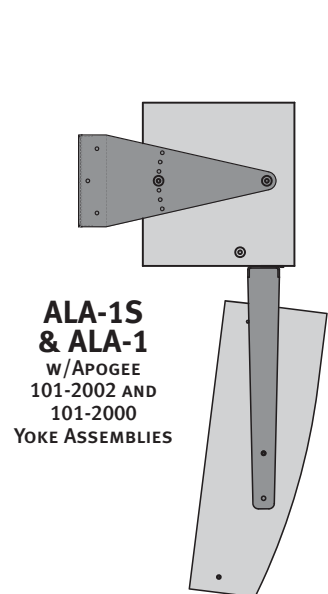

**ALA-1S
& ALA-1**
w/APOGEE
101-2002 AND
101-2000
YOKE ASSEMBLIES

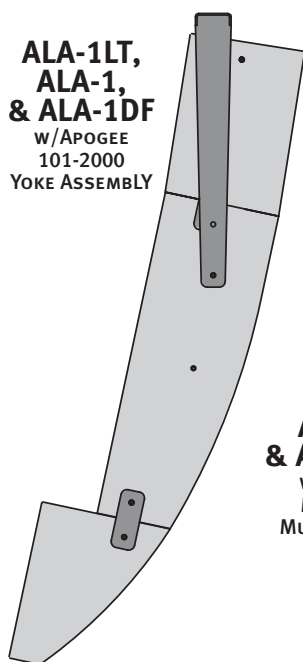

**ALA-1LT,
ALA-1,
& ALA-1DF**
w/APOGEE
101-2000
YOKE ASSEMBLY

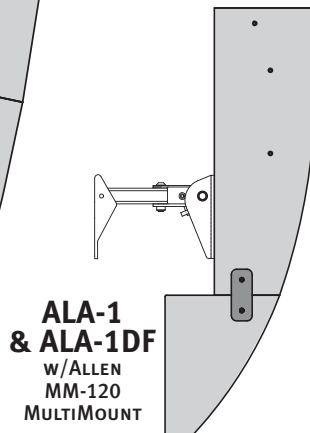

**ALA-1
& ALA-1DF**
w/ALLEN
MM-120
MULTIMOUNT

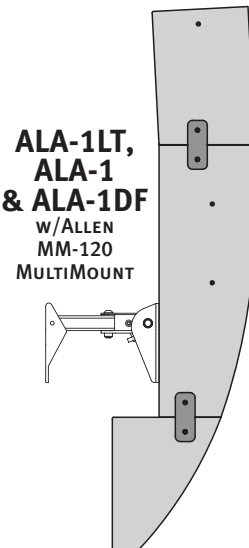

**ALA-1LT,
ALA-1
& ALA-1DF**
w/ALLEN
MM-120
MULTIMOUNT

RIGGING HARDWARE



ALA-1 YOKE
101-2000
(sold separately)



COUPLING PLATE
101-2001
(2 ea. included w/ALA-1S,
ALA-1DF, ALA-1LT)

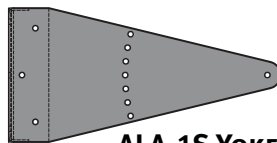

ALA-1S YOKE
101-2002
(sold separately)

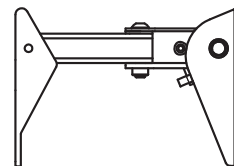

ALLEN PRODUCTS
MULTIMOUNT MM-120
(purchase direct from Allen)



TEL: 800-443-3979 • FAX: 800-999-9016 • www.apogee-sound.com